





- | | | |
|---|--|--------------|
| <p>■ CILINDRI DA APPLICARE
RIM CYLINDERS</p> |  | <p>P. 55</p> |
| <p>■ CILINDRI DA INFILARE
MORTICE CYLINDERS</p> |  | <p>P. 56</p> |
| <p>■ CILINDRI DA INFILARE CON RINFORZO E TAGLIO ANTITORSIONE BREVETTATO
MORTICE CYLINDERS WITH PATENTED REINFORCE AND CUT AGAINST BREAKING</p> |  | <p>P. 60</p> |
| <p>■ CILINDRI DA INFILARE MODULARI CON TAGLIO ANTITORSIONE BREVETTATO
MODULAR MORTICE CYLINDERS WITH PATENTED CUT AGAINST BREAKING</p> |  | <p>P. 64</p> |
| <p>■ CILINDRI OVALI (SOLO 5 PERNI)
OVAL CYLINDERS (ONLY 5 PINS)</p> |  | <p>P. 68</p> |
| <p>■ CILINDRI Ø 26 (15 PERNI)
Ø 26 CYLINDERS (15 PINS)</p> |  | <p>P. 68</p> |
| <p>■ CILINDRI Ø 22 (SOLO 5 PERNI)
Ø 22 CYLINDERS (ONLY 5 PINS)</p> |  | <p>P. 68</p> |
| <p>■ LUCCHETTO
PADLOCK</p> |  | <p>P. 69</p> |

SISTEMA BREVETTATO: CHIAVE CON ELEMENTO MOBILE PATENTED SYSTEM: KEY WITH MOBILE ELEMENT

- ✓ **Sistema a 15 perni attivi**
System with 15 active pins
- ✓ **Corpo in ottone nichelato**
Nickel plated brass body
- ✓ **Perni in acciaio temprato**
Hardened steel pins
- ✓ **Controperni in acciaio inox**
Stainless steel top pins
- ✓ **Molle in acciaio inox**
Stainless steel springs
- ✓ **Camma DIN 30° (cilindri da infilare)**
DIN 30° cam (mortice cylinders)
- ✓ **3 chiavi reversibili in alpaca con impugnatura rivestita in plastica, collo lungo e numerazione a codice indiretto sulla testa**
3 reversible keys in nickel silver with plastic-coated grip, long neck numbered on key head
- ✓ **Security card**
Security card
- ✓ **Vite di fissaggio**
Fixing screw

Brevetto Europeo
Scadenza 2022

European Patent
Date filed 2022

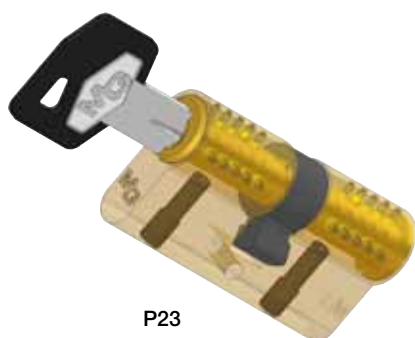

P23

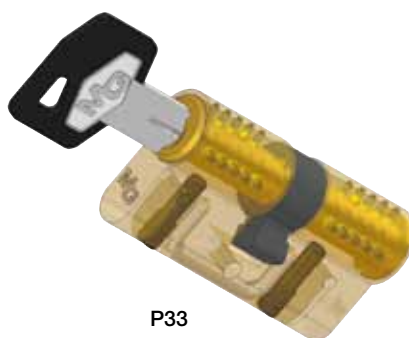

P33

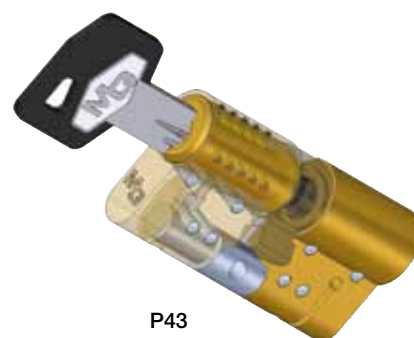

P43

Cilindro per art. 711
Cylinder for art. 711

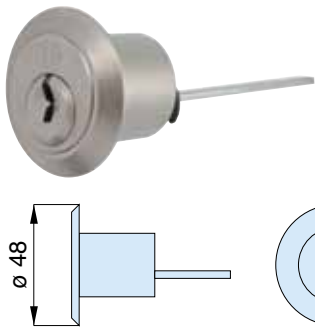

HSP



	A	B	C	D	L	codice code	euro	
15						P11000 N00		1
	con 5 chiavi with 5 keys					 N50	

Cilindro per art. 712
Cylinder for art. 712

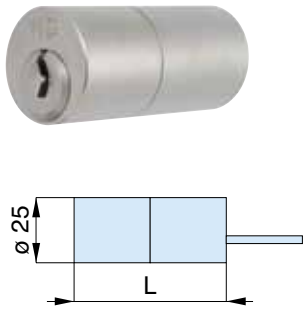

HSP



	A	B	C	D	L	codice code	euro	
15					50	P12500 N00		1
	con 5 chiavi with 5 keys					 N50	

Coppia cilindri
Double rim cylinder

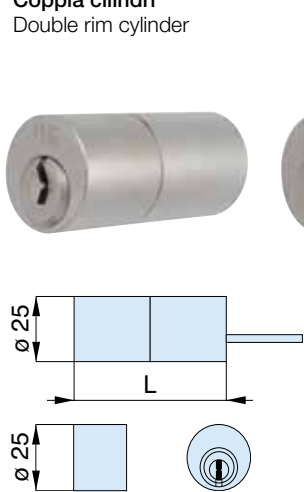

HSP



	A	B	C	D	L	codice code	euro	
15					50	P14500 N00		1
	con 5 chiavi with 5 keys					 N50	

Coppia cilindri
Double rim cylinder

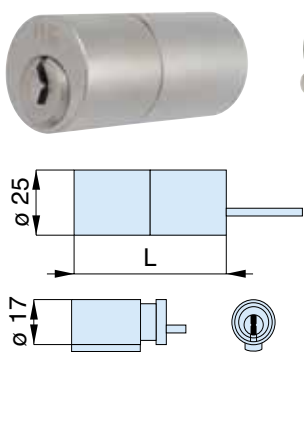

HSP



	A	B	C	D	L	codice code	euro	
15					50	P14501 N00		1
	con 5 chiavi with 5 keys					 N50	



CILINDRI DI SICUREZZA DA APPLICARE
security rim cylinders



Doppio cilindro
Double cylinder



HSP

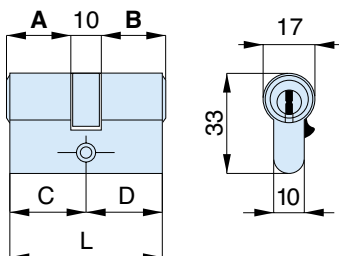

↓	A	B	C	D	L	codice code	euro	✎	📦
15	27	10	27	31	31	62	P23640 N00		1
15	27	10	31	31	35	66	P23680 N00		1
15	31	10	31	35	35	70	P23720 N00		1
15	27	10	37	31	41	72	P23740 N00		1
15	27	10	41	31	45	76	P23781 N00		1
15	31	10	37	35	41	76	P23782 N00		1
15	31	10	41	35	45	80	P23820 N00		1
15	27	10	47	31	51	80	P23841 N00		1
15	37	10	37	41	41	80	P23842 N00		1
15	27	10	51	31	55	86	P23881 N00		1
15	31	10	47	35	51	86	P23882 N00		1
15	37	10	41	41	45	86	P23883 N00		1
15	31	10	51	35	55	90	P23921 N00		1
15	41	10	41	45	45	90	P23922 N00		1
15	27	10	57	31	61	92	P23941 N00		1
15	37	10	47	41	51	92	P23942 N00		1
15	37	10	51	41	55	96	P23981 N00		1
15	41	10	47	45	51	96	P23982 N00		1
15	31	10	57	35	61	96	P23983 N00		1
15	41	10	51	45	55	100	P23020 N00		1
15	27	10	67	31	71	102	P23041 N00		1
15	37	10	57	41	61	102	P23042 N00		1
15	47	10	47	51	51	102	P23043 N00		1
15	27	10	77	31	81	112	P23141 N00		1
15	37	10	67	41	71	112	P23142 N00		1
15	47	10	57	51	61	112	P23143 N00		1
15	47	10	67	51	71	112	P23243 N00		1

con 5 chiavi with 5 keys

..... N50

frizionato frictioned

..... NOX

CILINDRI DI SICUREZZA DA INFILARE
security mortice cylinders

Mezzo cilindro con camma regolabile in 8 posizioni
Half cylinder with adjustable cam in 8 positions



HSP

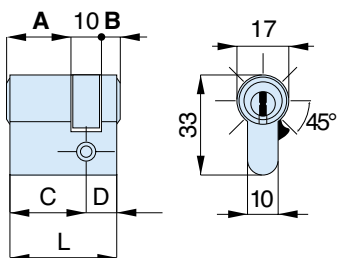

↓	A	B	C	D	L	codice code	euro	✎	📦
15	27	10	5	31	10	41	P24420 N00		1
15	31	10	5	35	10	45	P24460 N00		1
15	37	10	5	41	10	51	P24520 N00		1
15	41	10	5	45	10	55	P24560 N00		1
15	47	10	5	51	10	61	P24620 N00		1
15	57	10	5	61	10	71	P24720 N00		1
15	67	10	5	71	10	81	P24820 N00		1
15	77	10	5	81	10	91	P24920 N00		1

con 5 chiavi with 5 keys

..... N50

Mezzo cilindro per lucchetto di sicurezza P92 - nickel opaco
Half cylinder for security padlock P92 - matt nickel

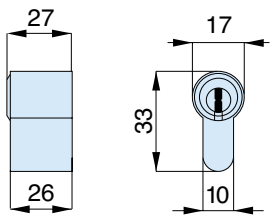

HSP

	A	B	C	D	L	codice code	euro	
15						P24270 N00		1
					 N50		

con 5 chiavi with 5 keys

Doppio cilindro con pomolo ottone nichelato opaco
Double cylinder with matt nickel-plated brass knob

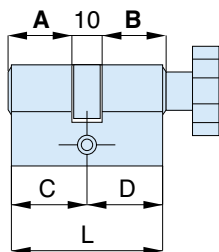
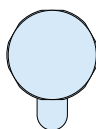

HSP

	A	B	C	D	L	codice code	euro	
15	27	10	27	31	31	62	P29640 NOR	1
15	27	10	31	31	35	66	P29681 NOR	1
15	31	10	27	35	31	66	P29682 NOR	1
15	31	10	31	35	35	70	P29720 NOR	1
15	27	10	37	31	41	72	P29741 NOR	1
15	37	10	27	41	31	72	P29742 NOR	1
15	27	10	41	31	45	76	P29781 NOR	1
15	41	10	27	45	31	76	P29782 NOR	1
15	31	10	37	35	41	76	P29783 NOR	1
15	37	10	31	41	35	76	P29784 NOR	1
15	31	10	41	35	45	80	P29821 NOR	1
15	41	10	31	45	35	80	P29822 NOR	1
15	27	10	47	31	51	82	P29841 NOR	1
15	47	10	27	51	31	82	P29842 NOR	1
15	37	10	37	41	41	82	P29843 NOR	1
15	27	10	51	31	55	86	P29881 NOR	1
15	31	10	47	35	51	86	P29882 NOR	1
15	37	10	41	41	45	86	P29883 NOR	1
15	41	10	37	45	41	86	P29884 NOR	1
15	31	10	51	35	55	90	P29921 NOR	1
15	41	10	41	45	45	90	P29922 NOR	1
15	27	10	57	31	61	92	P29941 NOR	1
15	37	10	47	41	51	92	P29942 NOR	1
15	37	10	51	41	55	96	P29981 NOR	1
15	41	10	47	45	51	96	P29982 NOR	1
15	41	10	51	45	55	100	P29020 NOR	1
15	27	10	67	31	71	102	P29041 NOR	1
15	37	10	57	41	61	102	P29042 NOR	1
15	47	10	47	51	51	102	P29043 NOR	1
15	27	10	77	31	81	112	P29141 NOR	1
15	37	10	67	41	71	112	P29142 NOR	1
15	47	10	57	51	61	112	P29143 NOR	1

con 5 chiavi with 5 keys

..... N5R



Doppio cilindro con pomolo ottone nichelato opaco
 Double cylinder with matt nickel-plated brass knob



HSP

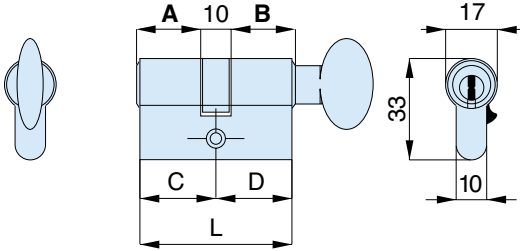

CILINDRI DI SICUREZZA DA INFILARE
security mortice cylinders

	A	B	C	D	L	codice code	euro		
15	27	10	27	31	31	62	P29640	N0F	1
15	27	10	31	31	35	66	P29681	N0F	1
15	31	10	27	35	31	66	P29682	N0F	1
15	31	10	31	35	35	70	P29720	N0F	1
15	27	10	37	31	41	72	P29741	N0F	1
15	37	10	27	41	31	72	P29742	N0F	1
15	27	10	41	31	45	76	P29781	N0F	1
15	41	10	27	45	31	76	P29782	N0F	1
15	31	10	37	35	41	76	P29783	N0F	1
15	37	10	31	41	35	76	P29784	N0F	1
15	31	10	41	35	45	80	P29821	N0F	1
15	41	10	31	45	35	80	P29822	N0F	1
15	27	10	47	31	51	82	P29841	N0F	1
15	47	10	27	51	31	82	P29842	N0F	1
15	37	10	37	41	41	82	P29843	N0F	1
15	27	10	51	31	55	86	P29881	N0F	1
15	31	10	47	35	51	86	P29882	N0F	1
15	37	10	41	41	45	86	P29883	N0F	1
15	41	10	37	45	41	86	P29884	N0F	1
15	31	10	51	35	55	90	P29921	N0F	1
15	41	10	41	45	45	90	P29922	N0F	1
15	27	10	57	31	61	92	P29941	N0F	1
15	37	10	47	41	51	92	P29942	N0F	1
15	37	10	51	41	55	96	P29981	N0F	1
15	41	10	47	45	51	96	P29982	N0F	1
15	41	10	51	45	55	100	P29020	N0F	1
15	27	10	67	31	71	102	P29041	N0F	1
15	37	10	57	41	61	102	P29042	N0F	1
15	47	10	47	51	51	102	P29043	N0F	1
15	27	10	77	31	81	112	P29141	N0F	1
15	37	10	67	41	71	112	P29142	N0F	1
15	47	10	57	51	61	112	P29143	N0F	1

con 5 chiavi with 5 keys

..... N5F

Doppio cilindro predisposto pomolo
Double cylinder with knob provision



HSP

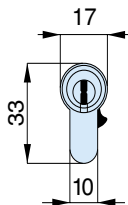
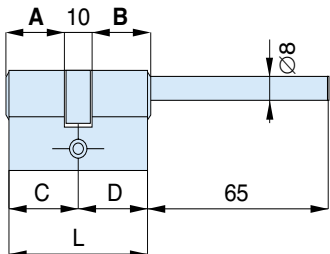

▽	A	B	C	D	L	codice code	euro	
15	27	10	27	31	31	62	P29640 N0L	1
15	31	10	27	35	31	66	P29680 N0L	1
15	37	10	27	41	31	72	P29740 N0L	1
15	41	10	27	45	31	76	P29780 N0L	1
15	47	10	27	51	31	82	P29840 N0L	1
15	51	10	27	55	31	86	P29880 N0L	1
15	57	10	27	61	31	92	P29940 N0L	1
15	67	10	27	71	31	102	P29040 N0L	1
15	77	10	27	81	31	112	P29140 N0L	1

con 5 chiavi with 5 keys

..... N5L

Doppio cilindro predisposto pomolo
Double cylinder with knob provision



HSP

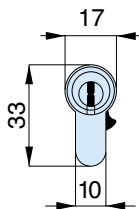
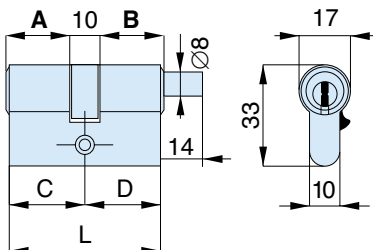

▽	A	B	C	D	L	codice code	euro	
15	27	10	27	31	31	62	P29640 N0C	1
15	27	10	31	31	35	66	P29681 N0C	1
15	31	10	27	35	31	66	P29682 N0C	1
15	31	10	31	35	35	70	P29720 N0C	1
15	27	10	37	31	41	72	P29741 N0C	1
15	37	10	27	41	31	72	P29742 N0C	1
15	27	10	41	31	45	76	P29781 N0C	1
15	41	10	27	45	31	76	P29782 N0C	1
15	31	10	37	35	41	76	P29783 N0C	1
15	37	10	31	41	35	76	P29784 N0C	1
15	31	10	41	35	45	80	P29821 N0C	1
15	41	10	31	45	35	80	P29822 N0C	1
15	27	10	47	31	51	82	P29841 N0C	1
15	47	10	27	51	31	82	P29842 N0C	1
15	37	10	37	41	41	82	P29843 N0C	1
15	27	10	51	31	55	86	P29881 N0C	1
15	31	10	47	35	51	86	P29882 N0C	1
15	37	10	41	41	45	86	P29883 N0C	1
15	41	10	37	45	41	86	P29884 N0C	1
15	31	10	51	35	55	90	P29921 N0C	1
15	41	10	41	45	45	90	P29922 N0C	1
15	27	10	57	31	61	92	P29941 N0C	1
15	37	10	47	41	51	92	P29942 N0C	1
15	37	10	51	41	55	96	P29981 N0C	1
15	41	10	47	45	51	96	P29982 N0C	1
15	41	10	51	45	55	100	P29020 N0C	1
15	27	10	67	31	71	102	P29041 N0C	1
15	37	10	57	41	61	102	P29042 N0C	1
15	47	10	47	51	51	102	P29043 N0C	1
15	27	10	77	31	81	112	P29141 N0C	1
15	37	10	67	41	71	112	P29142 N0C	1
15	47	10	57	51	61	112	P29143 N0C	1

con 5 chiavi with 5 keys

..... N5C



Doppio cilindro con rinforzo e taglio
Double cylinder with reinforce and cut



HSP

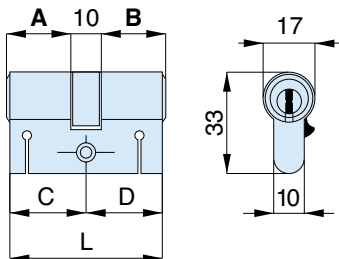

CILINDRI DI SICUREZZA DA INFILARE
security mortice cylinders

↓	A	B	C	D	L	codice code	euro	✎	📦
15	27	10	27	31	31	62	P33640 N00		1
15	27	10	31	31	35	66	P33680 N00		1
15	31	10	31	35	35	70	P33720 N00		1
15	27	10	37	31	41	72	P33740 N00		1
15	27	10	41	31	45	76	P33781 N00		1
15	31	10	37	35	41	76	P33782 N00		1
15	31	10	41	35	45	80	P33820 N00		1
15	27	10	47	31	51	82	P33841 N00		1
15	37	10	37	41	41	82	P33842 N00		1
15	27	10	51	31	55	86	P33881 N00		1
15	31	10	47	35	51	86	P33882 N00		1
15	37	10	41	41	45	86	P33883 N00		1
15	31	10	51	35	55	90	P33921 N00		1
15	41	10	41	45	45	90	P33922 N00		1
15	27	10	57	31	61	92	P33941 N00		1
15	37	10	47	41	51	92	P33942 N00		1
15	37	10	51	41	55	96	P33981 N00		1
15	41	10	47	45	51	96	P33982 N00		1
15	31	10	57	35	61	96	P33983 N00		1
15	41	10	51	45	55	100	P33020 N00		1
15	27	10	67	31	71	102	P33041 N00		1
15	37	10	57	41	61	102	P33042 N00		1
15	47	10	47	51	51	102	P33043 N00		1
15	27	10	77	31	81	112	P33141 N00		1
15	37	10	67	41	71	112	P33142 N00		1
15	47	10	57	51	61	112	P33143 N00		1
15	47	10	67	51	71	122	P33243 N00		1

con 5 chiavi with 5 keys

..... N50

frizionato frictioned

..... NOX

Mezzo cilindro con taglio e camma regolabile in 8 posizioni
Half cylinder with cut and adjustable cam in 8 positions



HSP

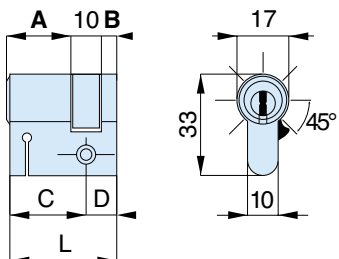

↓	A	B	C	D	L	codice code	euro	✎	📦
15	27	10	5	31	10	41	P34420 N00		1
15	31	10	5	35	10	45	P34460 N00		1
15	37	10	5	41	10	51	P34520 N00		1
15	41	10	5	45	10	55	P34560 N00		1
15	47	10	5	51	10	61	P34620 N00		1
15	57	10	5	61	10	71	P34720 N00		1
15	67	10	5	71	10	81	P34820 N00		1
15	77	10	5	81	10	91	P34920 N00		1

con 5 chiavi with 5 keys

..... N50

Doppio cilindro con pomolo ottone nichelato opaco con rinforzo e taglio
 Double cylinder with matt nickel-plated brass knob with reinforce and cut

HSP

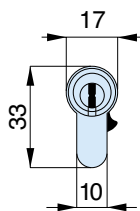
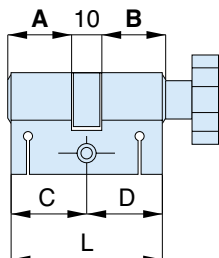
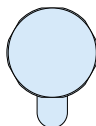

▽	A	B	C	D	L	codice code	euro	
15	27	10	27	31	31	62	P39640 NOR	1
15	27	10	31	31	35	66	P39681 NOR	1
15	31	10	27	35	31	66	P39682 NOR	1
15	31	10	31	35	35	70	P39720 NOR	1
15	27	10	37	31	41	72	P39741 NOR	1
15	37	10	27	41	31	72	P39742 NOR	1
15	27	10	41	31	45	76	P39781 NOR	1
15	41	10	27	45	31	76	P39782 NOR	1
15	31	10	37	35	41	76	P39783 NOR	1
15	37	10	31	41	35	76	P39784 NOR	1
15	31	10	41	35	45	80	P39821 NOR	1
15	41	10	31	45	35	80	P39822 NOR	1
15	27	10	47	31	51	82	P39841 NOR	1
15	47	10	27	51	31	82	P39842 NOR	1
15	37	10	37	41	41	82	P39843 NOR	1
15	27	10	51	31	55	86	P39881 NOR	1
15	31	10	47	35	51	86	P39882 NOR	1
15	37	10	41	41	45	86	P39883 NOR	1
15	41	10	37	45	41	86	P39884 NOR	1
15	31	10	51	35	55	90	P39921 NOR	1
15	41	10	41	45	45	90	P39922 NOR	1
15	27	10	57	31	61	92	P39941 NOR	1
15	37	10	47	41	51	92	P39942 NOR	1
15	37	10	51	41	55	96	P39981 NOR	1
15	41	10	47	45	51	96	P39982 NOR	1
15	41	10	51	45	55	100	P39020 NOR	1
15	27	10	67	31	71	102	P39041 NOR	1
15	37	10	57	41	61	102	P39042 NOR	1
15	47	10	47	51	51	102	P39043 NOR	1
15	27	10	77	31	81	112	P39141 NOR	1
15	37	10	67	41	71	112	P39142 NOR	1
15	47	10	57	51	61	112	P39143 NOR	1

con 5 chiavi with 5 keys

..... N5R

CILINDRI DI SICUREZZA DA INFILARE
security mortice cylinders





Doppio cilindro con pomolo ottone nichelato opaco con rinforzo e taglio
 Double cylinder with matt nickel-plated brass knob with reinforce and cut



HSP

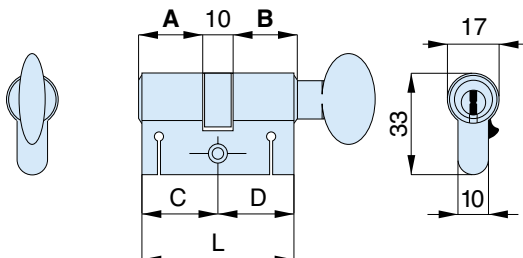

CILINDRI DI SICUREZZA DA INFILARE
security mortice cylinders

	A	B	C	D	L	codice code	euro		
15	27	10	27	31	31	62	P39640	N0F	1
15	27	10	31	31	35	66	P39681	N0F	1
15	31	10	27	35	31	66	P39682	N0F	1
15	31	10	31	35	35	70	P39720	N0F	1
15	27	10	37	31	41	72	P39741	N0F	1
15	37	10	27	41	31	72	P39742	N0F	1
15	27	10	41	31	45	76	P39781	N0F	1
15	41	10	27	45	31	76	P39782	N0F	1
15	31	10	37	35	41	76	P39783	N0F	1
15	37	10	31	41	35	76	P39784	N0F	1
15	31	10	41	35	45	80	P39821	N0F	1
15	41	10	31	45	35	80	P39822	N0F	1
15	27	10	47	31	51	82	P39841	N0F	1
15	47	10	27	51	31	82	P39842	N0F	1
15	37	10	37	41	41	82	P39843	N0F	1
15	27	10	51	31	55	86	P39881	N0F	1
15	31	10	47	35	51	86	P39882	N0F	1
15	37	10	41	41	45	86	P39883	N0F	1
15	41	10	37	45	41	86	P39884	N0F	1
15	31	10	51	35	55	90	P39921	N0F	1
15	41	10	41	45	45	90	P39922	N0F	1
15	27	10	57	31	61	92	P39941	N0F	1
15	37	10	47	41	51	92	P39942	N0F	1
15	37	10	51	41	55	96	P39981	N0F	1
15	41	10	47	45	51	96	P39982	N0F	1
15	41	10	51	45	55	100	P39020	N0F	1
15	27	10	67	31	71	102	P39041	N0F	1
15	37	10	57	41	61	102	P39042	N0F	1
15	47	10	47	51	51	102	P39043	N0F	1
15	27	10	77	31	81	112	P39141	N0F	1
15	37	10	67	41	71	112	P39142	N0F	1
15	47	10	57	51	61	112	P39143	N0F	1

con 5 chiavi with 5 keys

..... N5F

Doppio cilindro predisposto pomolo con rinforzo e taglio
 Double cylinder with knob provision with reinforce and cut



HSP

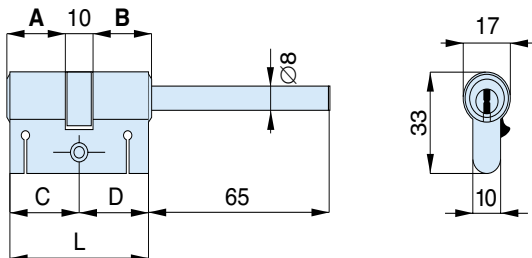

▽	A	B	C	D	L	codice code	euro		
15	27	10	27	31	31	62	P39640	NOL	1
15	31	10	27	35	31	66	P39680	NOL	1
15	37	10	27	41	31	72	P39740	NOL	1
15	41	10	27	45	31	76	P39780	NOL	1
15	47	10	27	51	31	82	P39840	NOL	1
15	51	10	27	55	31	86	P39880	NOL	1
15	57	10	27	61	31	92	P39940	NOL	1
15	67	10	27	71	31	102	P39040	NOL	1
15	77	10	27	81	31	112	P39140	NOL	1

con 5 chiavi with 5 keys

..... N5L

Doppio cilindro predisposto pomolo con rinforzo e taglio
 Double cylinder with knob provision with reinforce and cut

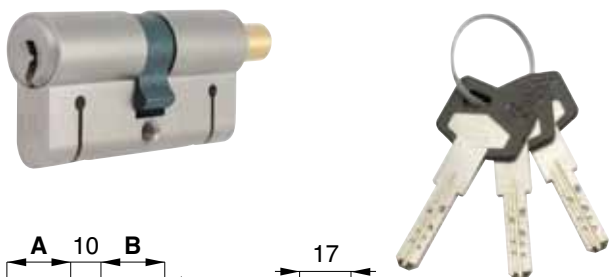

HSP

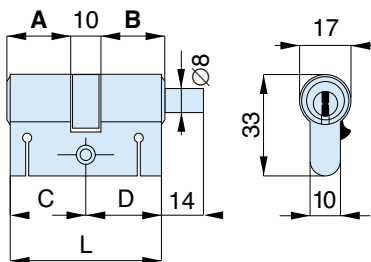

▽	A	B	C	D	L	codice code	euro		
15	27	10	27	31	31	62	P39640	NOC	1
15	27	10	31	31	35	66	P39681	NOC	1
15	31	10	27	35	31	66	P39682	NOC	1
15	31	10	31	35	35	70	P39720	NOC	1
15	27	10	37	31	41	72	P39741	NOC	1
15	37	10	27	41	31	72	P39742	NOC	1
15	27	10	41	31	45	76	P39781	NOC	1
15	41	10	27	45	31	76	P39782	NOC	1
15	31	10	37	35	41	76	P39783	NOC	1
15	37	10	31	41	35	76	P39784	NOC	1
15	31	10	41	35	45	80	P39821	NOC	1
15	41	10	31	45	35	80	P39822	NOC	1
15	27	10	47	31	51	82	P39841	NOC	1
15	47	10	27	51	31	82	P39842	NOC	1
15	37	10	37	41	41	82	P39843	NOC	1
15	27	10	51	31	55	86	P39881	NOC	1
15	31	10	47	35	51	86	P39882	NOC	1
15	37	10	41	41	45	86	P39883	NOC	1
15	41	10	37	45	41	86	P39884	NOC	1
15	31	10	51	35	55	90	P39921	NOC	1
15	41	10	41	45	45	90	P39922	NOC	1
15	27	10	57	31	61	92	P39941	NOC	1
15	37	10	47	41	51	92	P39942	NOC	1
15	37	10	51	41	55	96	P39981	NOC	1
15	41	10	47	45	51	96	P39982	NOC	1
15	41	10	51	45	55	100	P39020	NOC	1
15	27	10	67	31	71	102	P39041	NOC	1
15	37	10	57	41	61	102	P39042	NOC	1
15	47	10	47	51	51	102	P39043	NOC	1
15	27	10	77	31	81	112	P39141	NOC	1
15	37	10	67	41	71	112	P39142	NOC	1
15	47	10	57	51	61	112	P39143	NOC	1

con 5 chiavi with 5 keys

..... N5C

CILINDRI DI SICUREZZA DA INFILARE
 security mortice cylinders





Doppio cilindro MODULARE con taglio
MODULAR double cylinder with cut



HSP

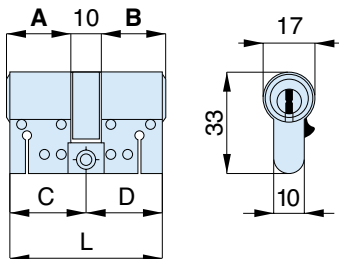

CILINDRI DI SICUREZZA DA INFILARE
security mortice cylinders

↓	A	B	C	D	L	codice code	euro	✎	📄
15	27	10	27	31	31	62	P43640 N00		1
15	27	10	31	31	35	66	P43680 N00		1
15	31	10	31	35	35	70	P43720 N00		1
15	27	10	37	31	41	72	P43740 N00		1
15	27	10	41	31	45	76	P43781 N00		1
15	31	10	37	35	41	76	P43782 N00		1
15	31	10	41	35	45	80	P43820 N00		1
15	27	10	47	31	51	82	P43841 N00		1
15	37	10	37	41	41	82	P43842 N00		1
15	27	10	51	31	55	86	P43881 N00		1
15	31	10	47	35	51	86	P43882 N00		1
15	37	10	41	41	45	86	P43883 N00		1
15	31	10	51	35	55	90	P43921 N00		1
15	41	10	41	45	45	90	P43922 N00		1
15	27	10	57	31	61	92	P43941 N00		1
15	37	10	47	41	51	92	P43942 N00		1
15	37	10	51	41	55	96	P43981 N00		1
15	41	10	47	45	51	96	P43982 N00		1
15	31	10	57	35	61	96	P43983 N00		1
15	41	10	51	45	55	100	P43020 N00		1
15	27	10	67	31	71	102	P43041 N00		1
15	37	10	57	41	61	102	P43042 N00		1
15	47	10	47	51	51	102	P43043 N00		1
15	27	10	77	31	81	112	P43141 N00		1
15	37	10	67	41	71	112	P43142 N00		1
15	47	10	57	51	61	112	P43143 N00		1
15	47	10	67	51	71	122	P43243 N00		1

con 5 chiavi with 5 keys

..... N50

frizionato frictioned

..... NOX

Cilindro valutato in base alla norma Europea EN 1303:05
Cylinder measured by means of the EN 1303:05 standard

Con la versione modulare si possono produrre cilindri fino alla lunghezza totale di 212 mm. (121-91)
With the modular version, it's possible to realize cylinders till the following total length: 212 mm (121-91)

Mezzo cilindro MODULARE con taglio e camma regolabile in 8 posizioni
MODULAR half cylinder with cut and adjustable cam in 8 positions



HSP

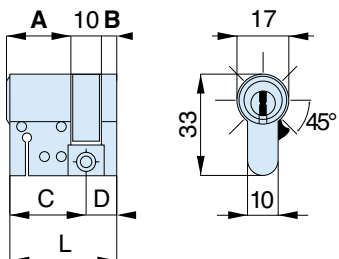

↓	A	B	C	D	L	codice code	euro	✎	📄
15	27	10	5	31	10	41	P44420 N00		1
15	31	10	5	35	10	45	P44460 N00		1
15	37	10	5	41	10	51	P44520 N00		1
15	41	10	5	45	10	55	P44560 N00		1
15	47	10	5	51	10	61	P44620 N00		1
15	57	10	5	61	10	71	P44720 N00		1
15	67	10	5	71	10	81	P44820 N00		1
15	77	10	5	81	10	91	P44920 N00		1

con 5 chiavi with 5 keys

..... N50

Doppio cilindro MODULARE con pomolo ottone nichelato opaco con taglio
 MODULAR double cylinder with matt nickel-plated brass knob with cut

HSP

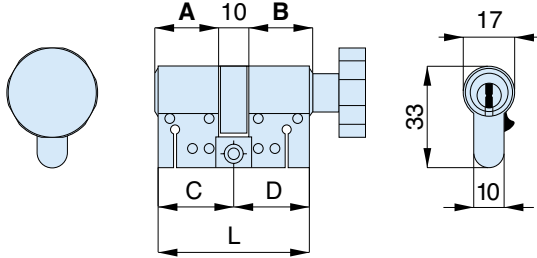

▽	A	B	C	D	L	codice code	euro	
15	27	10	27	31	31	62	P49640 NOR	1
15	27	10	31	31	35	66	P49681 NOR	1
15	31	10	27	35	31	66	P49682 NOR	1
15	31	10	31	35	35	70	P49720 NOR	1
15	27	10	37	31	41	72	P49741 NOR	1
15	37	10	27	41	31	72	P49742 NOR	1
15	27	10	41	31	45	76	P49781 NOR	1
15	41	10	27	45	31	76	P49782 NOR	1
15	31	10	37	35	41	76	P49783 NOR	1
15	37	10	31	41	35	76	P49784 NOR	1
15	31	10	41	35	45	80	P49821 NOR	1
15	41	10	31	45	35	80	P49822 NOR	1
15	27	10	47	31	51	82	P49841 NOR	1
15	47	10	27	51	31	82	P49842 NOR	1
15	37	10	37	41	41	82	P49843 NOR	1
15	27	10	51	31	55	86	P49881 NOR	1
15	31	10	47	35	51	86	P49882 NOR	1
15	37	10	41	41	45	86	P49883 NOR	1
15	41	10	37	45	41	86	P49884 NOR	1
15	31	10	51	35	55	90	P49921 NOR	1
15	41	10	41	45	45	90	P49922 NOR	1
15	27	10	57	31	61	92	P49941 NOR	1
15	37	10	47	41	51	92	P49942 NOR	1
15	37	10	51	41	55	96	P49981 NOR	1
15	41	10	47	45	51	96	P49982 NOR	1
15	41	10	51	45	55	100	P49020 NOR	1
15	27	10	67	31	71	102	P49041 NOR	1
15	37	10	57	41	61	102	P49042 NOR	1
15	47	10	47	51	51	102	P49043 NOR	1
15	27	10	77	31	81	112	P49141 NOR	1
15	37	10	67	41	71	112	P49142 NOR	1
15	47	10	57	51	61	112	P49143 NOR	1

con 5 chiavi with 5 keys

..... N5R

CILINDRI DI SICUREZZA DA INFILARE
security mortice cylinders





Doppio cilindro MODULARE con pomolo ottone nichelato opaco con taglio
 MODULAR double cylinder with matt nickel-plated brass knob with cut



HSP

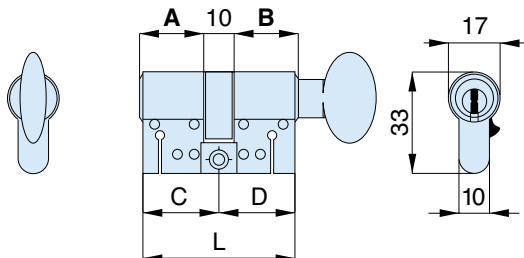

CILINDRI DI SICUREZZA DA INFILARE
security mortice cylinders

	A	B	C	D	L	codice code	euro		
15	27	10	27	31	31	62	P49640	N0F	1
15	27	10	31	31	35	66	P49681	N0F	1
15	31	10	27	35	31	66	P49682	N0F	1
15	31	10	31	35	35	70	P49720	N0F	1
15	27	10	37	31	41	72	P49741	N0F	1
15	37	10	27	41	31	72	P49742	N0F	1
15	27	10	41	31	45	76	P49781	N0F	1
15	41	10	27	45	31	76	P49782	N0F	1
15	31	10	37	35	41	76	P49783	N0F	1
15	37	10	31	41	35	76	P49784	N0F	1
15	31	10	41	35	45	80	P49821	N0F	1
15	41	10	31	45	35	80	P49822	N0F	1
15	27	10	47	31	51	82	P49841	N0F	1
15	47	10	27	51	31	82	P49842	N0F	1
15	37	10	37	41	41	82	P49843	N0F	1
15	27	10	51	31	55	86	P49881	N0F	1
15	31	10	47	35	51	86	P49882	N0F	1
15	37	10	41	41	45	86	P49883	N0F	1
15	41	10	37	45	41	86	P49884	N0F	1
15	31	10	51	35	55	90	P49921	N0F	1
15	41	10	41	45	45	90	P49922	N0F	1
15	27	10	57	31	61	92	P49941	N0F	1
15	37	10	47	41	51	92	P49942	N0F	1
15	37	10	51	41	55	96	P49981	N0F	1
15	41	10	47	45	51	96	P49982	N0F	1
15	41	10	51	45	55	100	P49020	N0F	1
15	27	10	67	31	71	102	P49041	N0F	1
15	37	10	57	41	61	102	P49042	N0F	1
15	47	10	47	51	51	102	P49043	N0F	1
15	27	10	77	31	81	112	P49141	N0F	1
15	37	10	67	41	71	112	P49142	N0F	1
15	47	10	57	51	61	112	P49143	N0F	1

con 5 chiavi with 5 keys

..... N5F

Doppio cilindro MODULARE predisposto pomolo con taglio
 MODULAR double cylinder with knob provision with cut



HSP

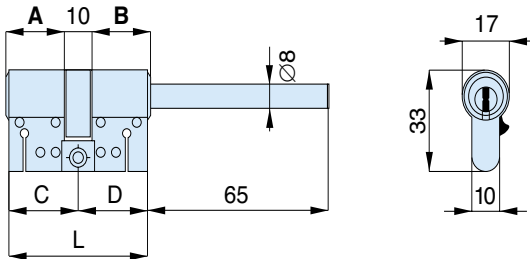

▽	A	B	C	D	L	codice code	euro	
15	27	10	27	31	31	62	P49640 N0L	1
15	31	10	27	35	31	66	P49680 N0L	1
15	37	10	27	41	31	72	P49740 N0L	1
15	41	10	27	45	31	76	P49780 N0L	1
15	47	10	27	51	31	82	P49840 N0L	1
15	51	10	27	55	31	86	P49880 N0L	1
15	57	10	27	61	31	92	P49940 N0L	1
15	67	10	27	71	31	102	P49040 N0L	1
15	77	10	27	81	31	112	P49140 N0L	1

con 5 chiavi with 5 keys

..... N5L

Doppio cilindro MODULARE predisposto pomolo con taglio
 MODULAR double cylinder with knob provision with cut

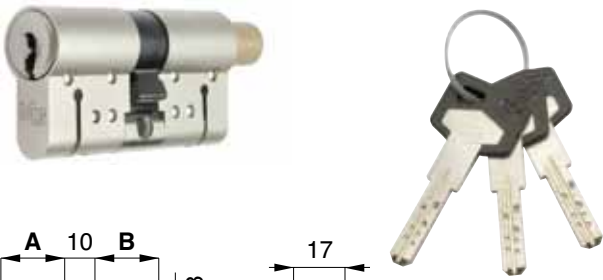

HSP

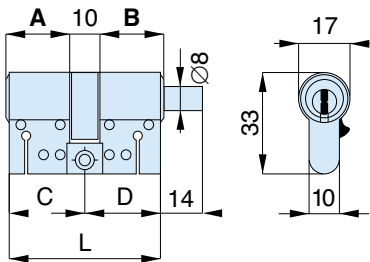

▽	A	B	C	D	L	codice code	euro	
15	27	10	27	31	31	62	P49640 N0C	1
15	27	10	31	31	35	66	P49681 N0C	1
15	31	10	27	35	31	66	P49682 N0C	1
15	31	10	31	35	35	70	P49720 N0C	1
15	27	10	37	31	41	72	P49741 N0C	1
15	37	10	27	41	31	72	P49742 N0C	1
15	27	10	41	31	45	76	P49781 N0C	1
15	41	10	27	45	31	76	P49782 N0C	1
15	31	10	37	35	41	76	P49783 N0C	1
15	37	10	31	41	35	76	P49784 N0C	1
15	31	10	41	35	45	80	P49821 N0C	1
15	41	10	31	45	35	80	P49822 N0C	1
15	27	10	47	31	51	82	P49841 N0C	1
15	47	10	27	51	31	82	P49842 N0C	1
15	37	10	37	41	41	82	P49843 N0C	1
15	27	10	51	31	55	86	P49881 N0C	1
15	31	10	47	35	51	86	P49882 N0C	1
15	37	10	41	41	45	86	P49883 N0C	1
15	41	10	37	45	41	86	P49884 N0C	1
15	31	10	51	35	55	90	P49921 N0C	1
15	41	10	41	45	45	90	P49922 N0C	1
15	27	10	57	31	61	92	P49941 N0C	1
15	37	10	47	41	51	92	P49942 N0C	1
15	37	10	51	41	55	96	P49981 N0C	1
15	41	10	47	45	51	96	P49982 N0C	1
15	41	10	51	45	55	100	P49020 N0C	1
15	27	10	67	31	71	102	P49041 N0C	1
15	37	10	57	41	61	102	P49042 N0C	1
15	47	10	47	51	51	102	P49043 N0C	1
15	27	10	77	31	81	112	P49141 N0C	1
15	37	10	67	41	71	112	P49142 N0C	1
15	47	10	57	51	61	112	P49143 N0C	1

con 5 chiavi with 5 keys

..... N5C





Doppio cilindro ovale
Double oval cylinder

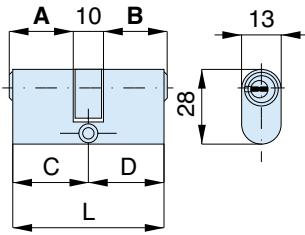

Per cilindri P18 sono previsti solo impianti a chiave uguale
For the cylinders P18 are foreseen just key alike systems

HSP

	A	B	C	D	L	codice code	euro		
5	27	10	27	31	31	P18640 N00			1

con 5 chiavi with 5 keys

..... N50

Doppio cilindro Ø 26
Double cylinder Ø 26

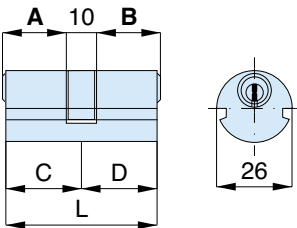

HSP

	A	B	C	D	L	codice code	euro		
15	27	10	27	31	31	P19640 N00			1
15	27	10	47	31	51	P19841 N00			1

con 5 chiavi with 5 keys

..... N50

Doppio cilindro Ø 22
Double cylinder Ø 22

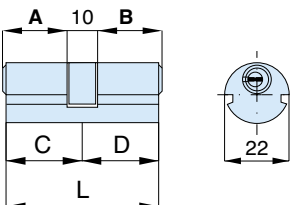

HSP

	A	B	C	D	L	codice code	euro		
5	27	10	27	31	31	P20640 N00			1

con 5 chiavi with 5 keys

..... N50

Per cilindri P20 sono previsti solo impianti a chiave uguale
For the cylinders P20 are foreseen just key alike systems

Lucchetto di sicurezza - nickel opaco
 Security padlock - matt nickel



HSP

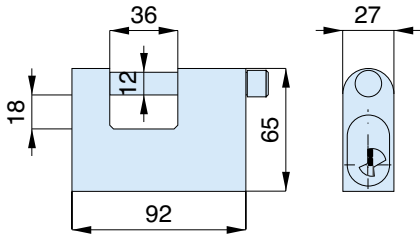

finiture finishing	codice code	euro	
acciaio steel	P92000 N00		1
con 5 chiavi with 5 keys N50		

CILINDRI DI SICUREZZA DA INFILARE
security mortice cylinders